

Fundamentals of Tribology

“LUBRICANTS”



Lecture by

Dr. Mukund Dutt Sharma

Assistant Professor

Mechanical Engineering Department

National Institute of Technology

Srinagar – 190 006 (J.K.) India

E-Mail: mukund.sharma@nitsri.net

Website: <http://nitsri.ac.in/>

Contents

- Lubrication
- Lubrication Regimes
- Hydrodynamic and Hydrostatic Lubrication
- Theory of Lubrication
- Lubrication system

4/11/2020

NATIONAL INSTITUTE OF
TECHNOLOGY, SRINAGAR, J & K,
INDIA



Lubrication

INTRODUCTION

- The object of lubrication is to reduce friction, wear, and heating of machine parts that move relative to each other.
- A lubricant is any substance that, when inserted between the moving surfaces accomplishes these purposes.
- In a sleeve bearing a shaft, or journal rotates oscillates within a sleeve, or bushing and the relative motion is sliding.
- In an antifriction bearing, the main relative motion is rolling.
- A follower may either roll or slide on the cam. Gear teeth mate with each other by a combination of rolling or sliding. Piston slides within their cylinders. All these application require lubrication to reduce friction, wear and heating.



Hydrodynamic and Hydrostatic Lubrication

- ❖ Hydrodynamic Lubrication :- Formed the oil film by the relative movement of the friction surface.
- ❖ Hydrostatic Lubrication :- Formed the oil film on the friction surface by the external pressure oil.

Hydrodynamic lubrication means that the load carrying surfaces of the bearing are separated by a relatively thick film of the lubricant, so as to prevent metal to metal contact, and that the stability thus obtained can be explained by the laws of fluid mechanics .

Hydrodynamic lubrication also called full film or fluid lubrication.

Hydrostatic lubrication is also obtained by introducing the lubricant, which is sometimes air or water, into the load bearing area at a pressure high enough to separate the surfaces with a relatively thick film of lubricant. So, unlike Hydrodynamic lubrication, the kind of lubrication does not require motion of one surface relative to other.

Lubrication Regimes

- Sliding friction is significantly reduced by an addition of a **lubricant** between the rubbing surfaces.
- **Engine bearings** are lubricated by **Engine oils** constantly supplied in sufficient amounts to the bearings surfaces.
- Lubricated friction is characterized by the presence of a thin film of the pressurized lubricant (**squeeze film**) between the surfaces of the bearing and the journal.
- The ratio of the squeeze film (oil film) thickness **h** to the surface roughness **Ra** determines the type of the lubrication regime:

Boundary lubrication ($h < Ra$)

- A constant contact between the friction surfaces at high surface points (microasperities) occurs at boundary lubrication.
- This regime is the most undesirable since it is characterized by high coefficient of friction (energy loss), increased wear, possibility of seizure between the bearing and journal materials, non-uniform distribution of the bearing load (localized pressure peaks).
- Very severe **engine bearing failures** are caused by boundary lubrication.
- Conditions for boundary lubrication are realized mainly at low speed friction (engine start and shutdown) and high loads.
- **Extreme pressure (EP) additives** in the lubricant prevent seizure conditions caused by direct metal-to-metal contact between the parts in the boundary lubrication regime.

Mixed lubrication ($h \sim Ra$)

- An intermittent contact between the friction surfaces at few high surface points (microasperities) occurs at mixed lubrication.
- Mixed lubrication is the intermediate regime between boundary lubrication and hydrodynamic friction.

Hydrodynamic lubrication ($h \gg Ra$)

- High rotation speed at relatively low bearing loads results in hydrodynamic friction, which is characterized by stable squeeze film (oil film) between the rubbing surfaces.
- No contact between the surfaces occurs in hydrodynamic lubrication.
- The squeeze film keeps the surfaces of the bearing and the shaft apart due to the force called **hydrodynamic lift** generated by the lubricant squeezed through the convergent gap between the eccentric journal and bearing.
- Bearings working under the conditions of hydrodynamic lubrication are called hydrodynamic journal bearings.

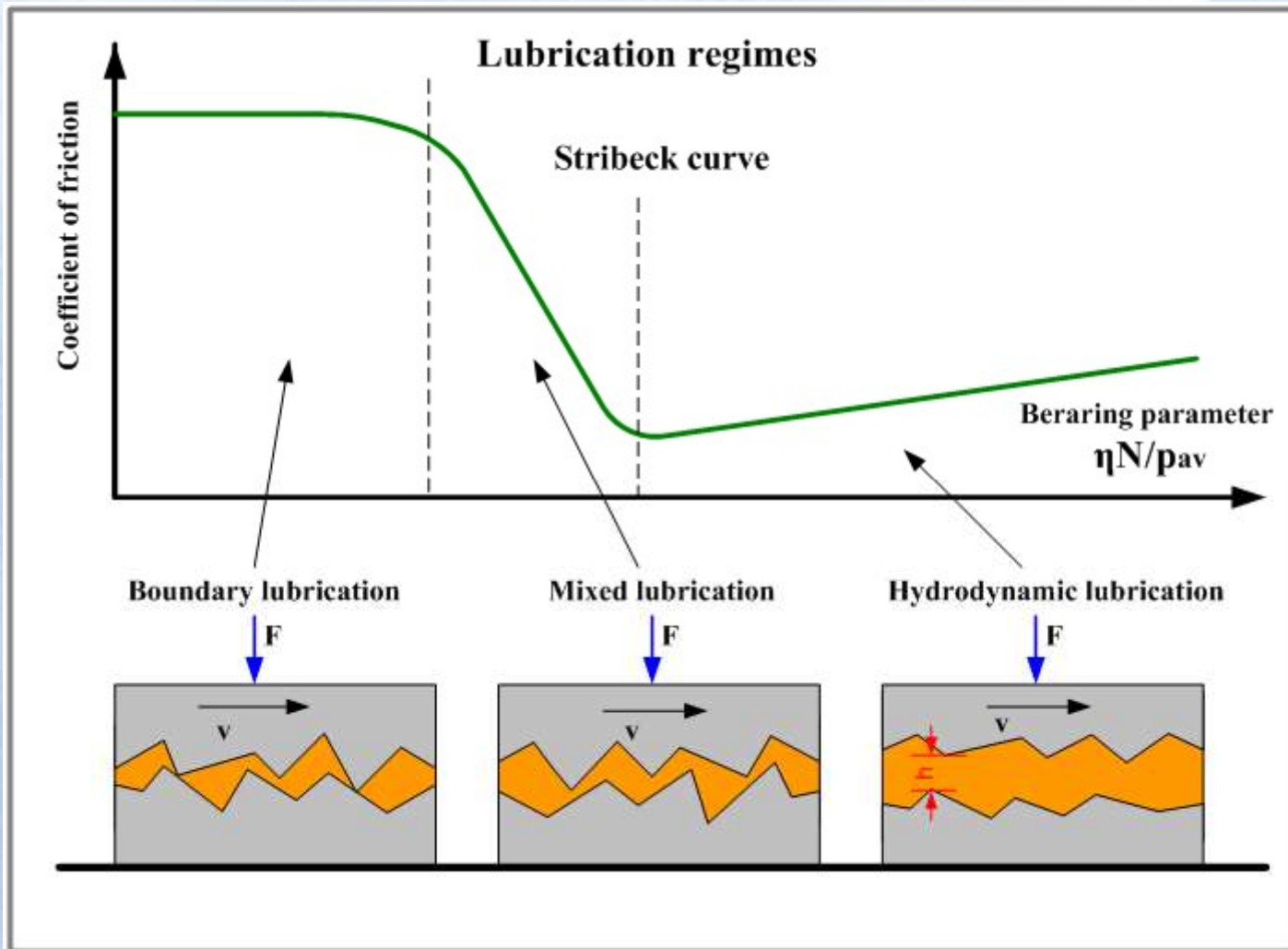

The three lubrication regimes are clearly distinguished in the Stribeck curve (see the figure above), which demonstrates the relationship between the coefficient of friction and the bearing parameter η^*N/p_{av} (η - dynamic viscosity of the lubricant, N - rotation speed, p_{av} - average bearing pressure).

Stability of different lubrication regimes may be explained by means of the Stribeck curve:

Temperature increase due to heat generated by friction causes drop of the lubricant viscosity and the bearing parameter.

According to the Stribeck curve decrease of the bearing parameter in mixed regime causes increase of the coefficient of friction followed by further temperature rise and consequent increase of the coefficient of friction. Thus mixed lubrication is unstable.

Increase of the bearing parameter due to temperature rise (lower viscosity) in hydrodynamic regime of lubrication causes the coefficient of friction to drop with consequent decrease of the temperature. The system corrects itself. Thus hydrodynamic lubrication is stable.

Hydrodynamic Lubrication

A theoretical analysis of **hydrodynamic lubrication** was carried out by Osborne Reynolds. The equations resulted from the analysis has served a basis for designing **hydrodynamically lubricated bearings**.

The following assumptions were made by Reynolds in the analysis:

The **lubricating fluid** is Newtonian - the flow is laminar and the shear stress between the flow layers is proportional to the velocity gradient in the direction perpendicular to the flow (Newton's law of viscosity):

$$\tau = \eta \frac{\partial v}{\partial y} \quad (1)$$

Where:

η – dynamic viscosity of oil,

v – linear velocity of the laminar layer,

y - the axis perpendicular to the flow direction.

The inertia forces resulted from from the accelerated movement of the flowing lubricant are neglected.

The lubricating fluid is incompressible.

The pressure of the fluid p is constant in the direction perpendicular to the laminar flow: **$dp/dy=0$** (assumption of thin lubrication film).

The viscosity of the fluid is constant throughout the lubrication film.

Consider the equilibrium of a unit volume in the lubricant film.

Hydrodynamic lubrication

- Also called **fluid-film**, thick-film, or flooded lubrication
- A thick film of **lubricant is interposed** between the surfaces of bodies in relative motion
- There has to be **pressure buildup** in the film due to relative motion of the surfaces
- Fluid friction is substituted for sliding friction
- Coefficient of friction is decreased
- Prevalent in **journal and thrust bearings**

Parallel surfaces

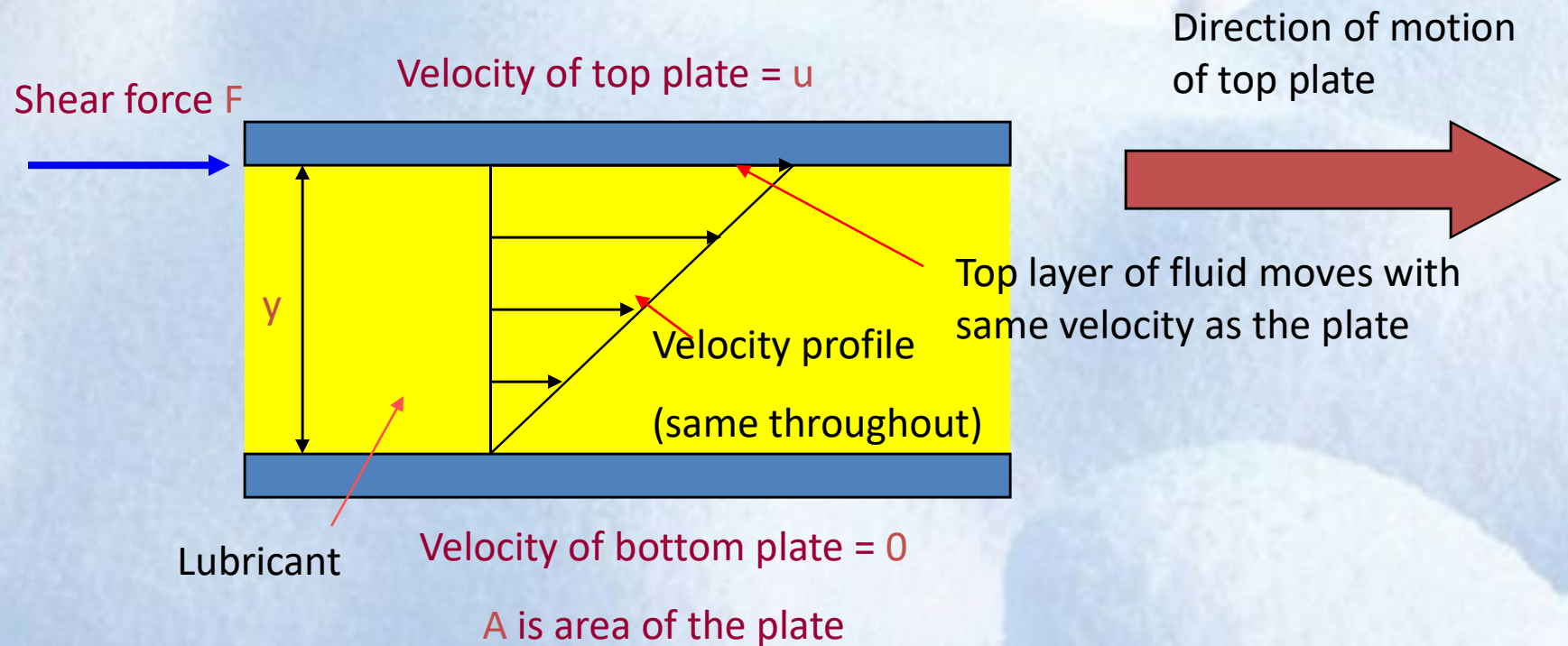

- There is no pressure buildup in the fluid due to relative motion
- It remains constant throughout influenced only by the load
- As load increases the surfaces are pushed towards each other until they are likely to touch

Hydrodynamic lubrication

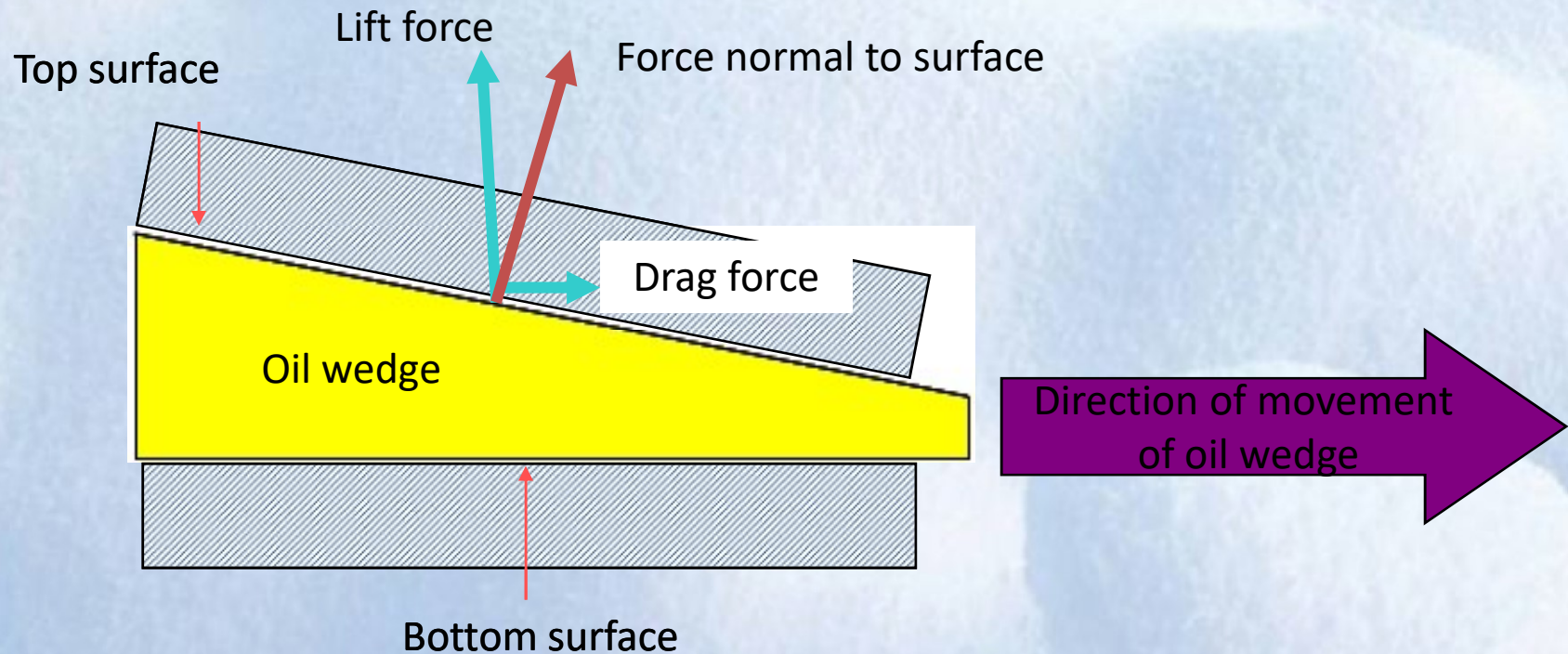

- Surfaces are **inclined** to each other thereby **compressing the fluid** as it flows.
- This leads to a **pressure buildup** that tends to force the surfaces apart
- **Larger loads** can be carried

Hydrodynamic theory- journal bearings

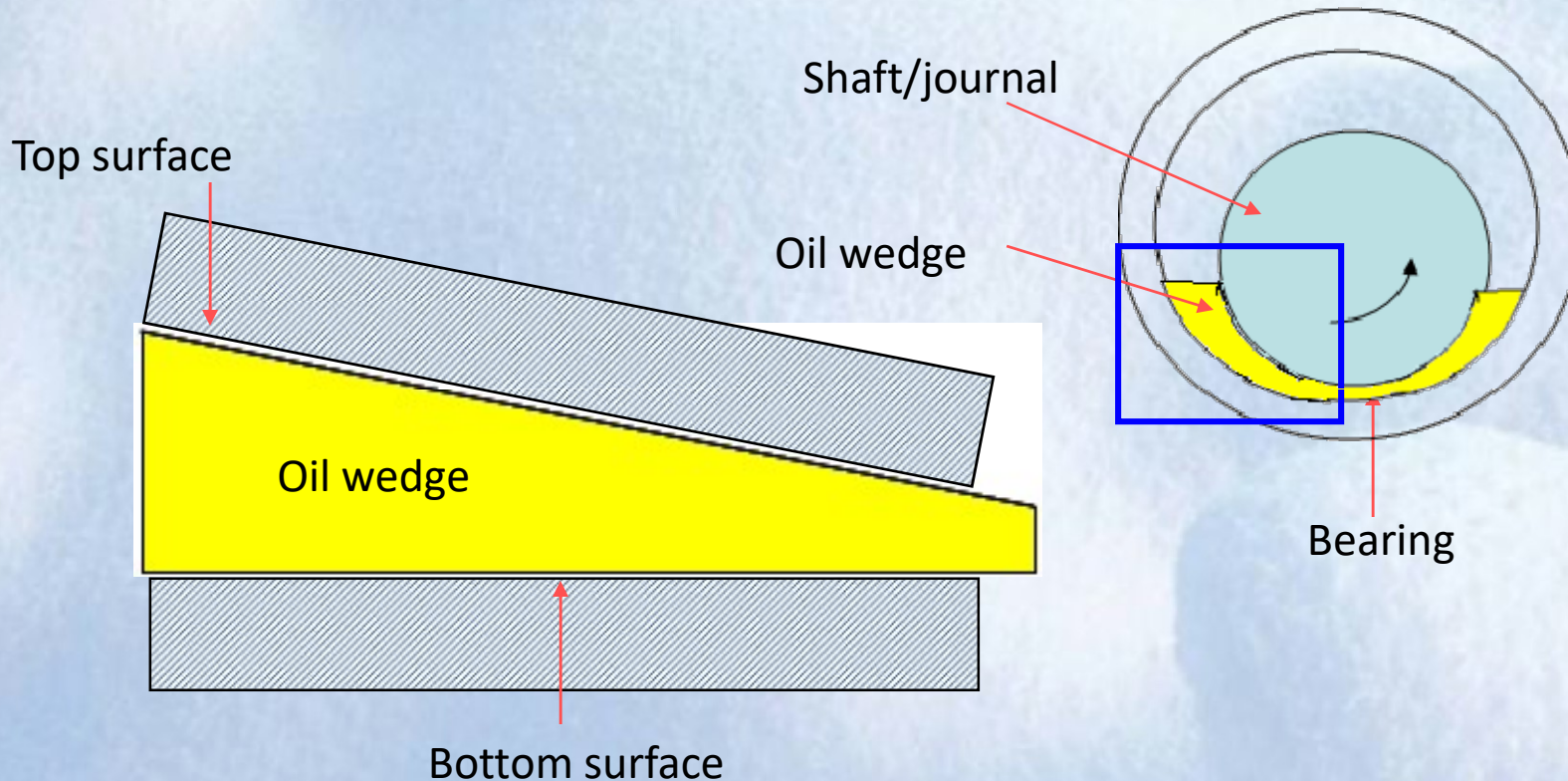

Oil wedge forms between shaft/journal and bearing due to them **not being concentric**

Velocity, pressure distribution

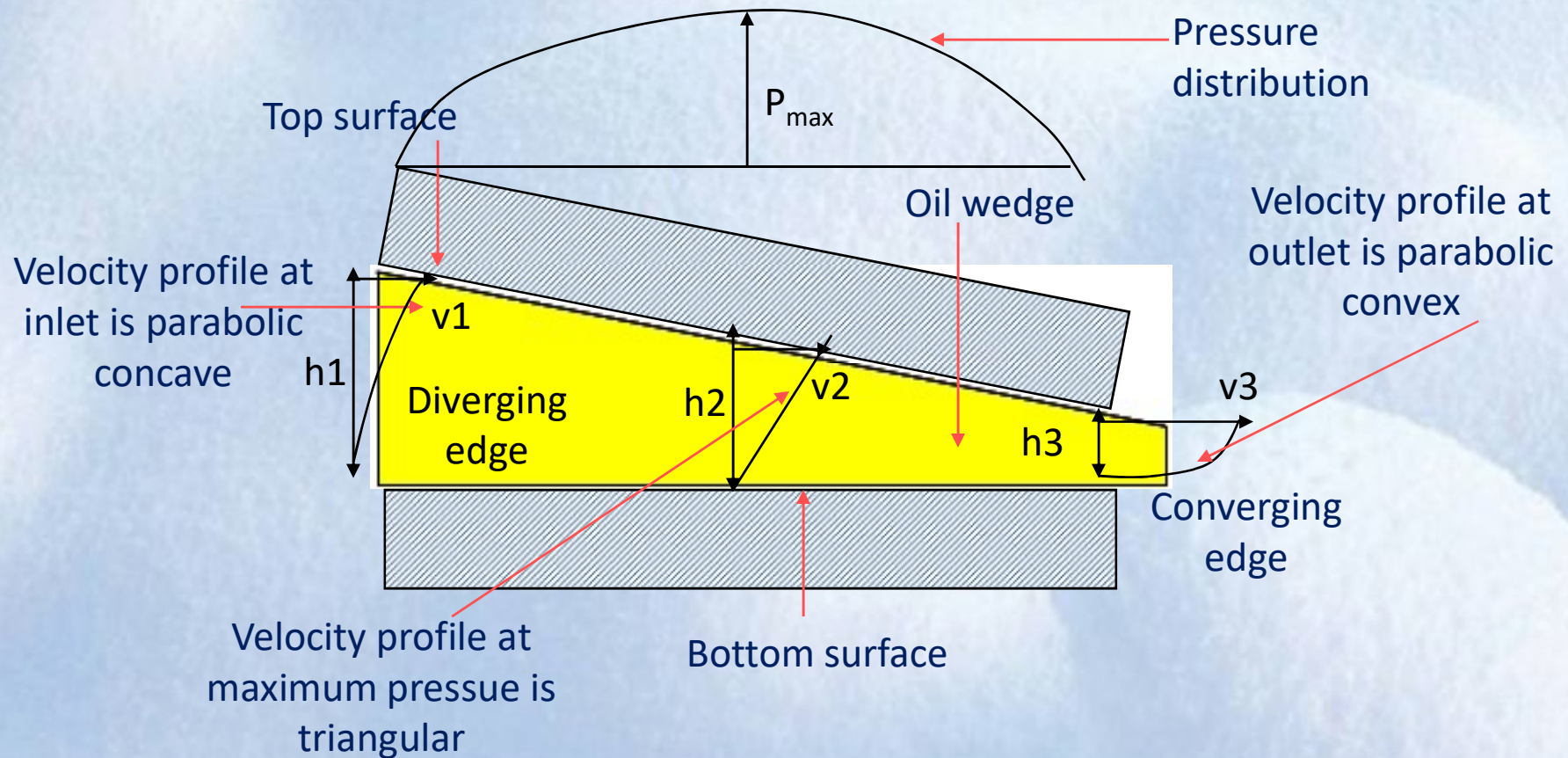

Volume rate of flow is same throughout the path, therefore as height of film decreases, the velocity has to increase ($v_3 > v_2 > v_1$)

Journal bearing- process at startup

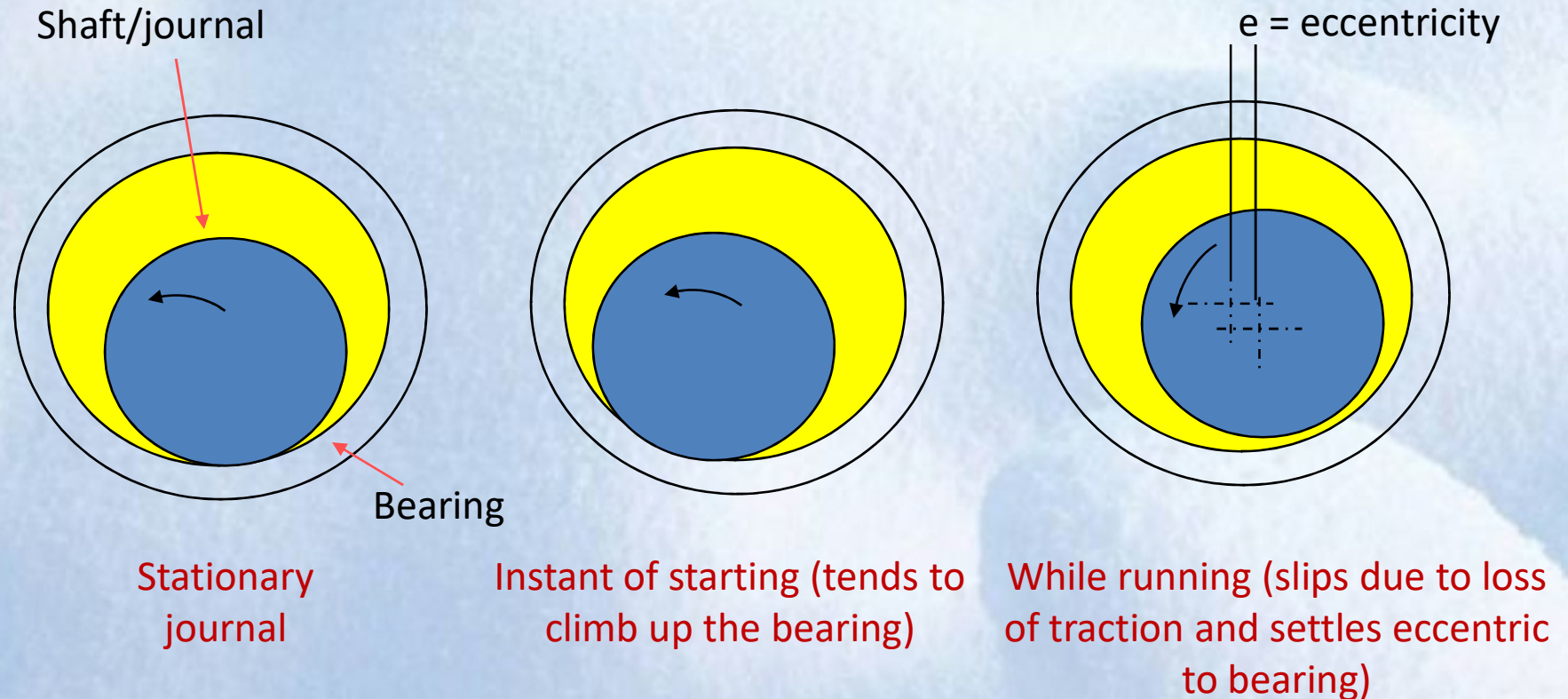

**Because of the eccentricity, the wedge is maintained
(lack of concentricity)**

Pressure distribution in a journal bearing

Shaft/journal

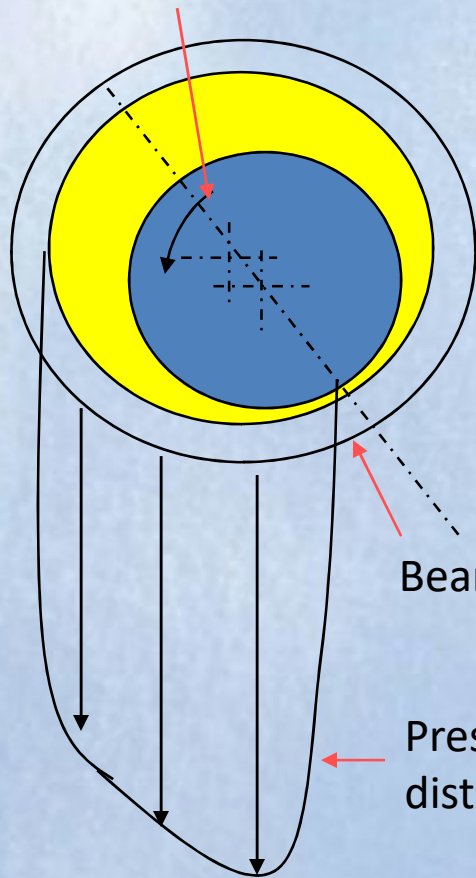

Bearing

Pressure distribution

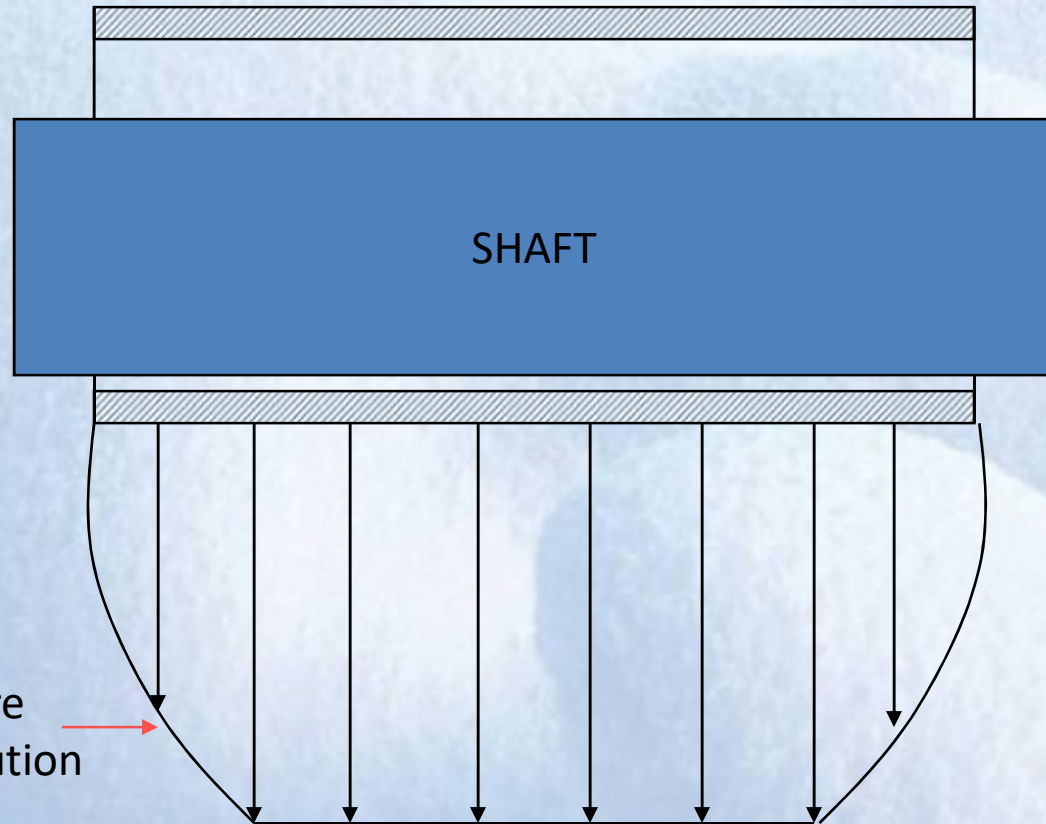

**Max. pressure is reached somewhere in between the inlet and outlet
(close to outlet)**

Tilting pad thrust bearings

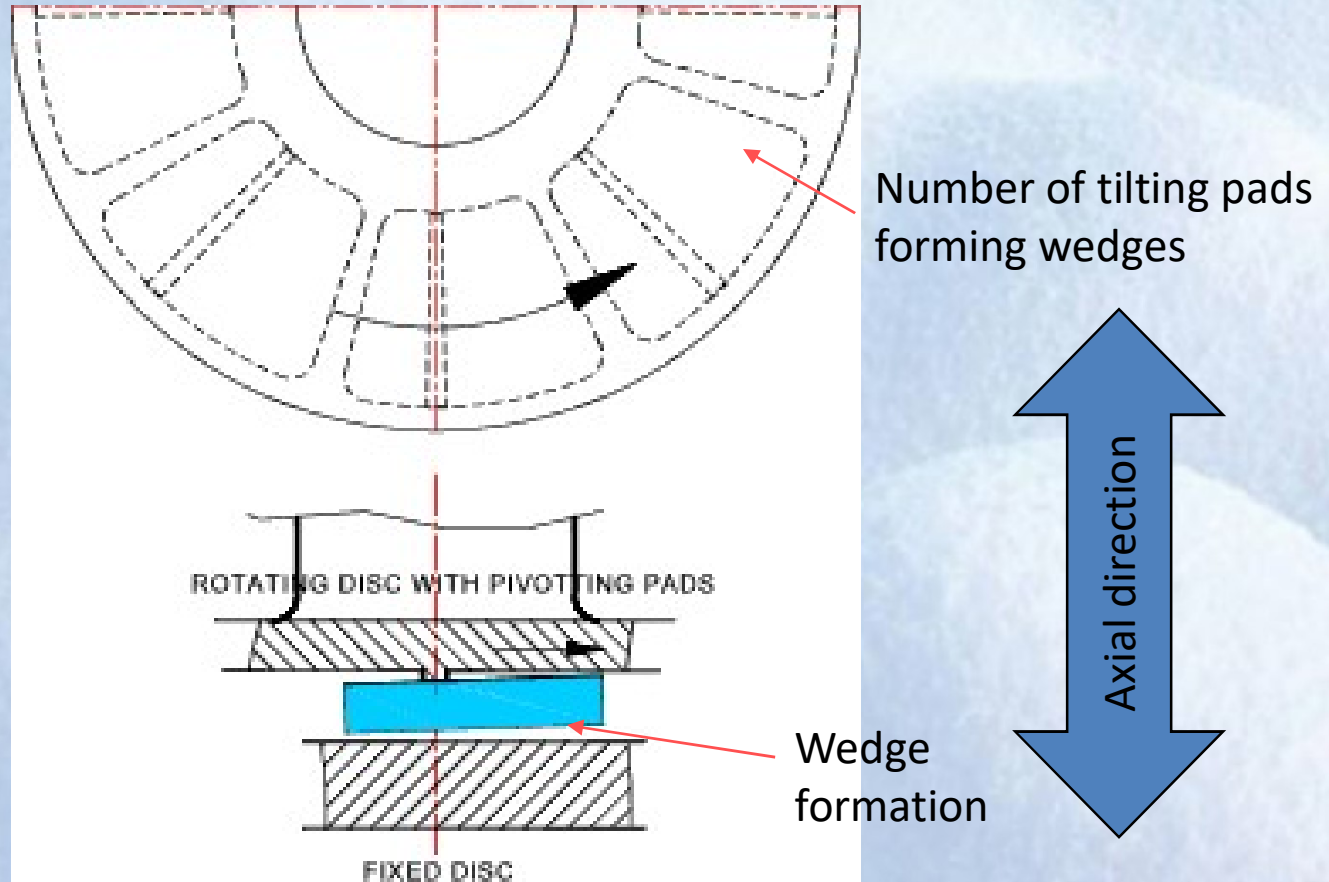

Tilting pad thrust bearing

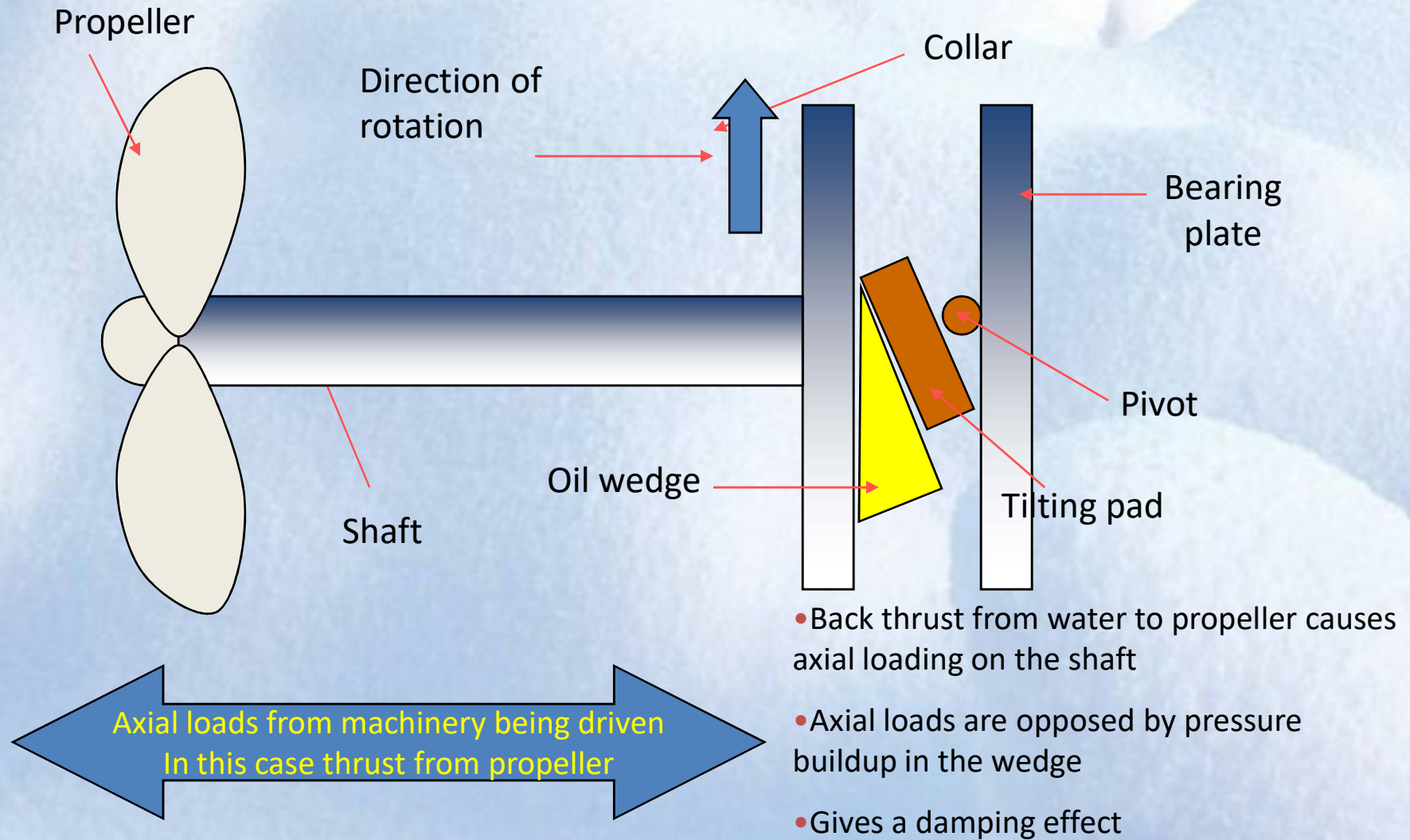

Hydrodynamic lubrication- characteristics

- Fluid film at the point of minimum **thickness decreases** in thickness as the **load increases**
- **Pressure** within the fluid mass **increases** as the film thickness decreases due to load
- **Pressure** within the fluid mass is **greatest at some point approaching minimum clearance** and lowest at the point of maximum clearance (due to divergence)
- **Viscosity** increases as pressure increases (more resistance to shear)

Hydrodynamic lubrication- characteristics

- **Film thickness** at the point of minimum clearance **increases** with the use of **more viscous fluids**
- With same load, the **pressure increases** as the **viscosity of fluid increases**
- With a given load and fluid, the **thickness** of the film will **increase** as **speed is increased**
- Fluid **friction increases** as the **viscosity** of the lubricant **becomes greater**

Hydrodynamic condition- Fluid velocity

- Fluid velocity depends on velocity of the journal or rider
- Increase in relative velocity tends towards a **decrease in eccentricity** of journal bearing centers
- This is accompanied by greater minimum film thickness

Hydrodynamic condition- Load

- Increase in load **decreases minimum film thickness**
- Also **increases pressure** within the film mass to provide a counteracting force
- Pressure acts in all directions, hence it tends to **squeeze the oil out** of the ends of the bearing
- Increase in pressure **increases fluid viscosity**

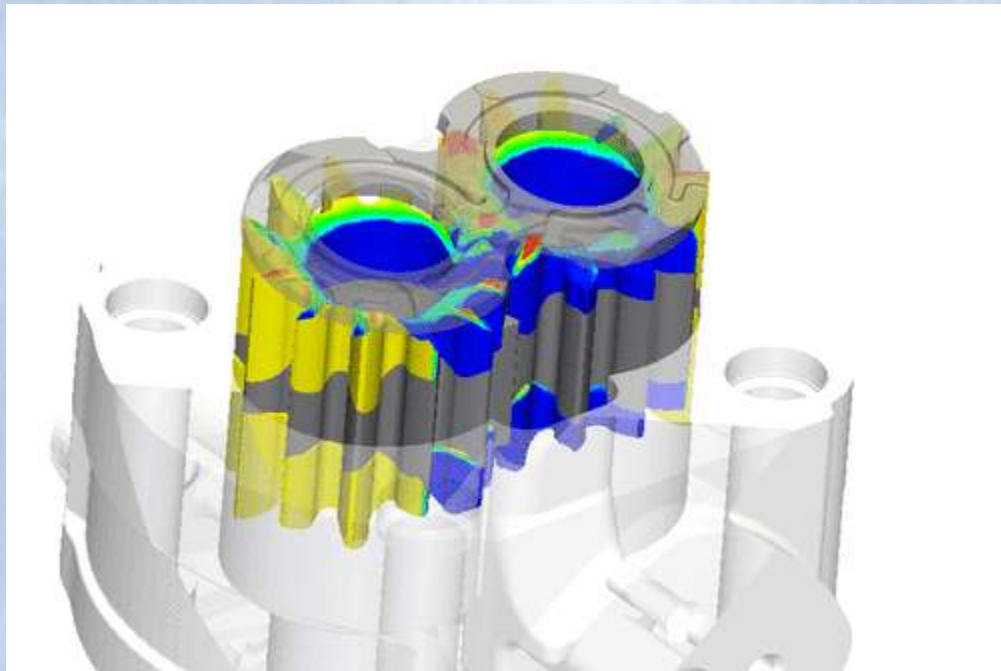
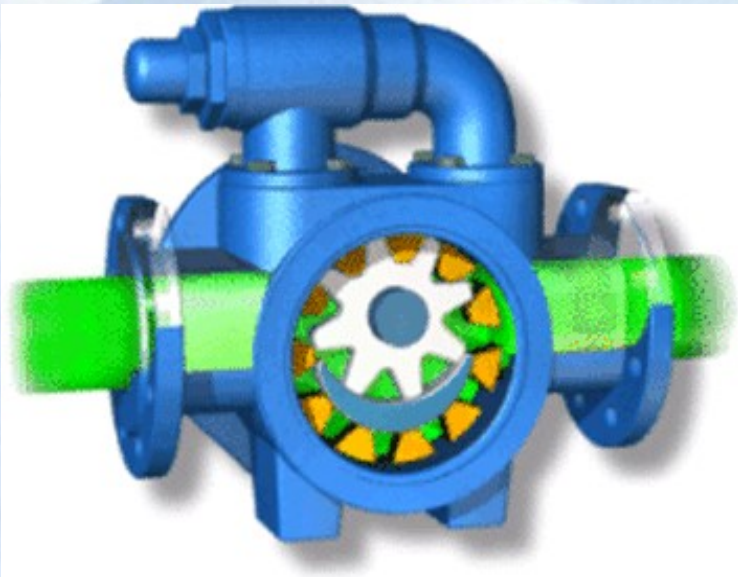
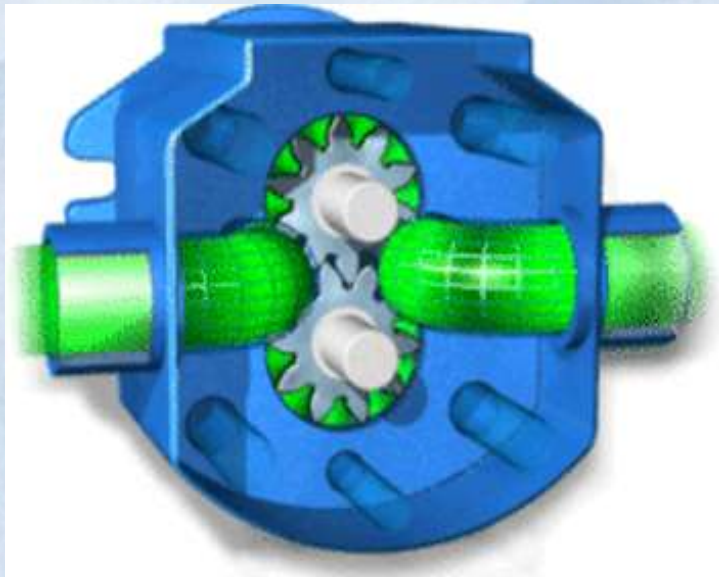

Functions of lubricating oil

- Reduces friction between the moving parts
- Reduces wear of the moving parts as far as possible
- Acts like a cooling medium
- Reduces noise between striking surfaces
- To provide sealing action
- To provide cushioning effect
- To provide cleaning action

Requirements of Lubricants

- Viscosity – high viscosity index (VI)
 - Petroleum lube oils – VI - 100-100
 - Can be increased to 120-130 by means of additives
- Physical stability
- Chemical stability
- Resistance against corrosion
- Flash point – should be high
- Cleanliness
- Resistance against extreme pressure

Types of lubricants

- Animal oils
- Vegetable oils
- Mineral oils
- Synthetic lubricants
- Greases
- Solid lubricants – Graphite

Viscosity rating

- **According to The Society of Automotive Engineers (SAE)**
 - **0W,5W,10W,20W,25W – for winter use**
 - **10,15,20,30,40,50,60,80,100,150,200,300 – for summer use**
 - **Multigrade oils – 10W/30**

Oil additives

The chemical substances which are added to the lubricating oil either to reinforce some of its natural properties or to provide it with certain new properties which it does not possess originally

- **Oxidation inhibitors** – amines, sulphides or phenols with metals like tin, zinc or barium
- **Corrosion inhibitors** - oxidation inhibitors with metal salts
- **Detergents** – high temperature deposits – gums and varnishes and **dispersants** – low temp deposits – cold sludge
- **Anti scuff additives** - to polish moving parts like piston, cylinder walls, cams etc.,
- **Viscosity index improvers**
- **Anti foaming additives** – polyorganosiloxanes

Parts which require lubrication

- Main crankshaft bearing
- Big end bearings
- Gudgeon pin bearings
- Piston rings and cylinder walls
- Timing gear
- Camshaft and camshaft bearings
- Valve mechanism
- Electrical equipment

LUBRICATION SYSTEM

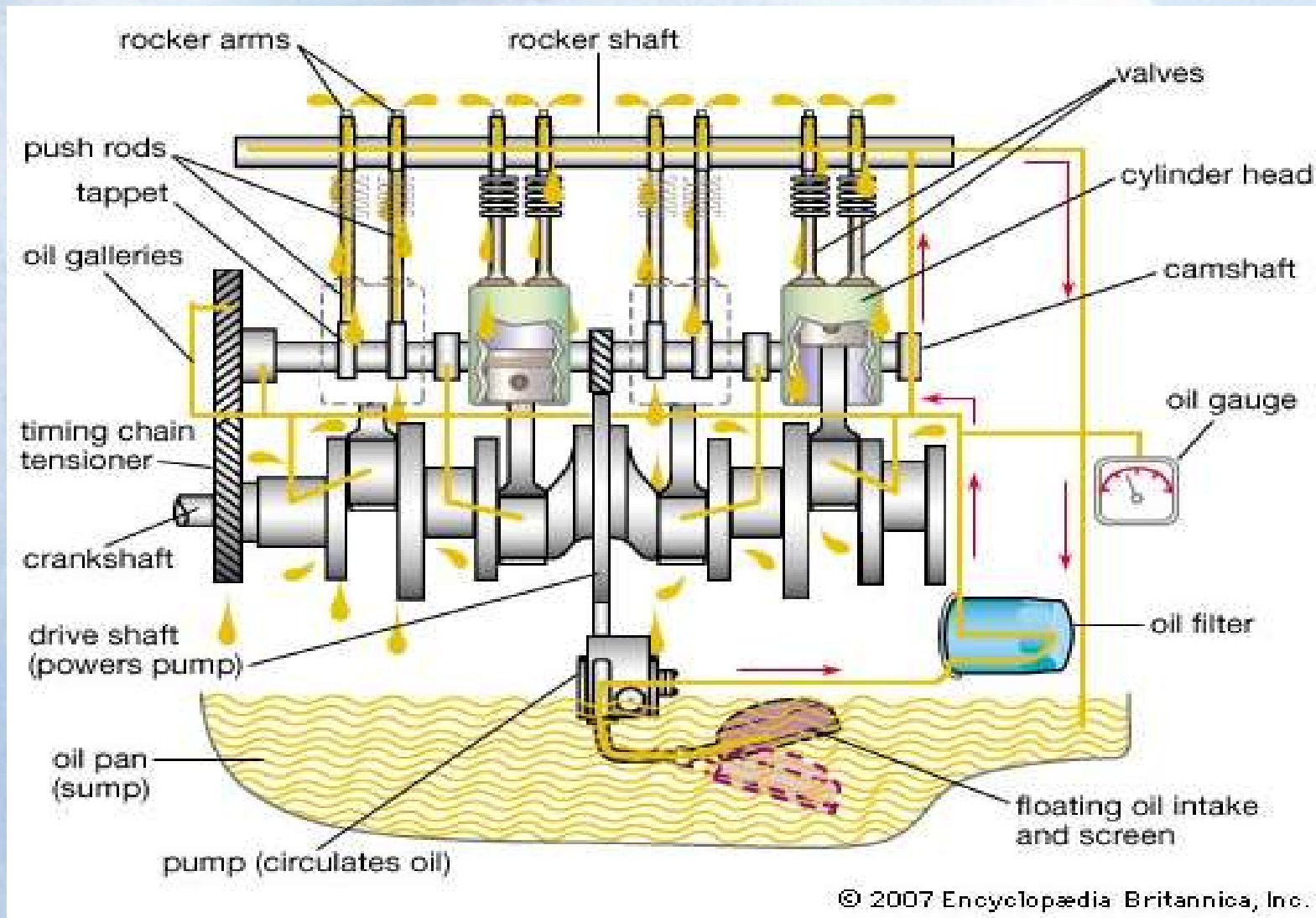

Purpose of Lubrication System

- Lubricate

Reduces Friction by creating a thin film (*Clearance*) between moving parts (*Bearings and journals*)

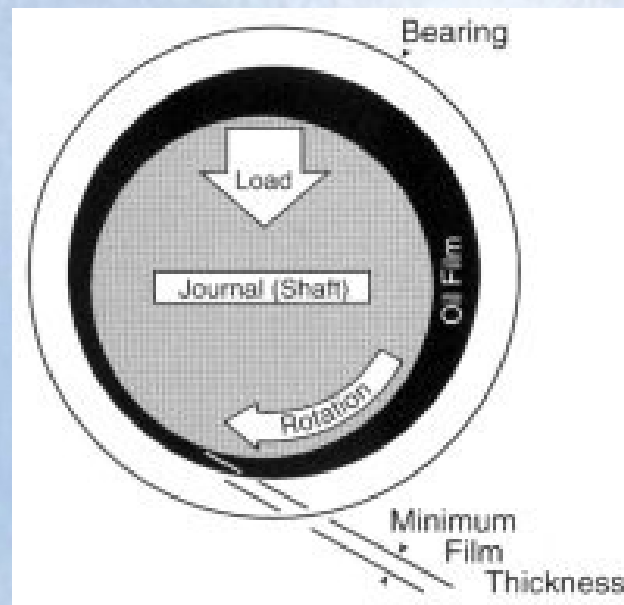

Purpose of Lubrication System

• Seals

The oil helps form a gastight seal between piston rings and cylinder walls
(*Reduces Blow-By*)

Internal oil leak (blow-by) will result in *BLUE SMOKE* at the tale pipe.

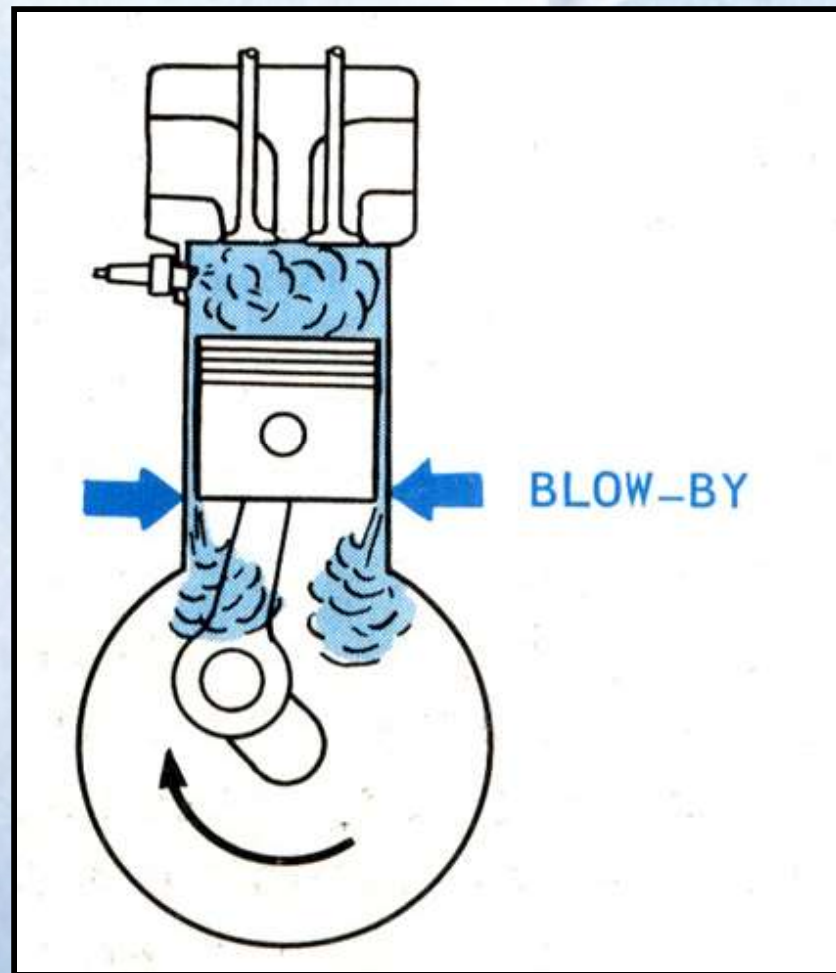

Purpose of Lubrication System

•Cleans

As it circulates through the engine, the oil picks up metal particles and carbon, and brings them back down to the pan.

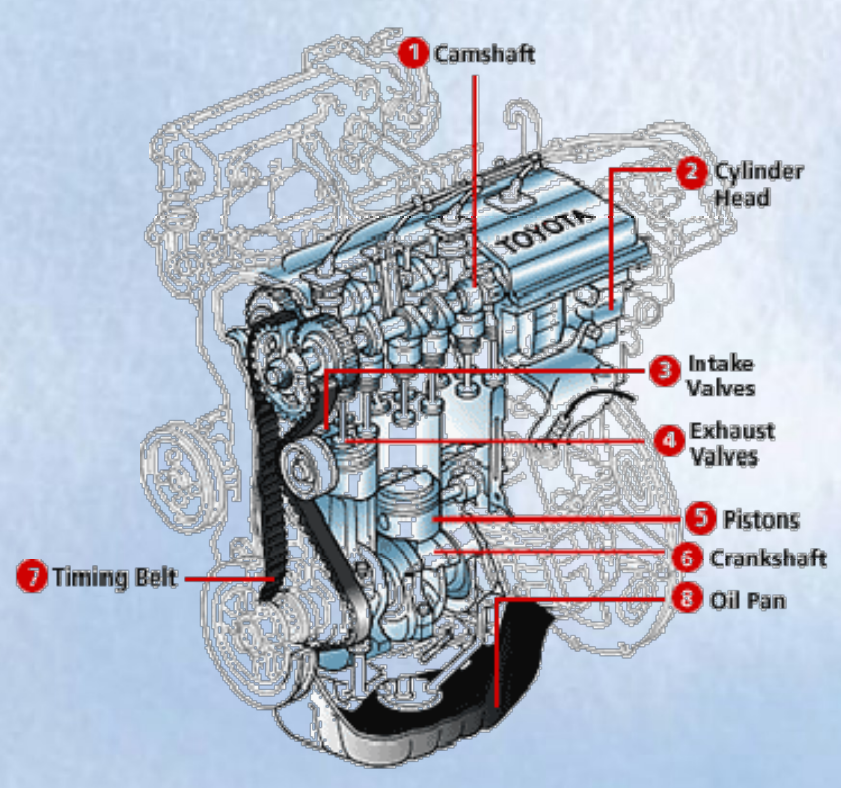

Purpose of Lubrication System

- Cools

Picks up heat when moving through the engine and then drops into the cooler oil pan, giving up some of this heat.



Purpose of Lubrication System

- Absorbs shock

When heavy loads are imposed on the bearings, the oil helps to cushion the load.

- Absorbs Contaminants

The additives in oil helps in absorbing the contaminants that enter the lubrication system.

END OF UNIT

Thank You

